



**Model GT1175 Electrical Installation Manual**  
**\*\*with U30 Microprocessor Control; Revision "E" Software\*\***  
P/N C-00198 Rev 10-1-19

Nabco Entrances Inc. S82 W18717 Gemini Drive Muskego, Wisconsin 53150  
Phone: (877) 622-2694 Fax: (888) 679-3319 www.nabcoentrances.com  
NABCO hours of Operation: Monday to Friday 8:00 a.m.- 4:30 p.m. (Central Time)

*Associated Manuals Part Numbers: U30 Microprocessor Control Setup and Programming Manual; Revision "E" Software P/N C-00203  
NABCO Price Book P/N 16-9244-30 (for Sensors, Switches, and Accessories)*

**WARNING**

- Turn OFF all power to the Automatic Door if a Safety System is not working.
- Instruct the Owner to keep all power turned OFF until corrective action can be achieved by a NABCO trained technician. Failure to follow these practices may result in serious consequences.
- NEVER leave a Door operating without all Safety detection systems operational.

**Table of Contents**

**CHAPTER 1: WARNING LABELS . . . . . 3**

**CHAPTER 2: GENERAL SAFETY RECOMMENDATIONS . . . . . 3**

**CHAPTER 3: SCOPE . . . . . 4**

SECTION 3.1: To the Installer . . . . . 4

**CHAPTER 4: ELECTRICAL SPECIFICATIONS . . . . . 4**

SECTION 4.1: Output Power Guideline . . . . . 5

**CHAPTER 5: 120 VAC GENERAL WIRING . . . . . 5**

**CHAPTER 6: GENERAL WIRING . . . . . 6**

SECTION 6.1: (2) Acusensor M and (1) Holding Beam (With Monitoring) . . . . . 6

SECTION 6.2: (2) Sensors and (1) Holding Beam (With Monitoring) . . . . . 7

SECTION 6.3: (2) Acusensor M for Sidelite Safety (Field Retrofit) . . . . . 8

**CHAPTER 7: CUSTOM WIRING. . . . . 9**

SECTION 7.1: U30 Configured for Remote Control - Switching from Two Way to One Way Mode . . . . . 9

SECTION 7.2: U30 Configured for Remote Control - Switching from Two Way to Night Mode . . . . . 10

SECTION 7.3: U30 using Card Reader or other Secure Activation Devices . . . . . 11

**CHAPTER 8: WIRING FOR LOCKS. . . . . 12**

SECTION 8.1: Electric Lock Wiring . . . . . 12

SECTION 8.2: Adjust the Strike . . . . . 12

SECTION 8.3: U30 with Fail Safe Electric Lock . . . . . 13

SECTION 8.4: U30 with Fail Secure Electric Lock . . . . . 14

SECTION 8.5: Magnetic Lock Wiring . . . . . 15

**CHAPTER 9: INFRARED HOLDING BEAMS . . . . . 16**

SECTION 9.1: Holding Beam for Slide Door . . . . . 16

SECTION 9.2: Holding Beam for Breakout . . . . . 17

**CHAPTER 10: TROUBLESHOOTING . . . . . 18**

**THIS PAGE IS INTENTIONALLY LEFT BLANK**

## CHAPTER 1: WARNING LABELS

Warning labels are universal and used to alert an individual of potential harm to one's self or to others. The following warning labels are listed in a hierarchy order that defines the most potential danger first, and the least potential danger last. Please refer to this page in the event that a warning label is displayed within this manual and further definition needs to be explained.

**DANGER**

Indicates potentially dangerous situations. Danger is used when there is a hazardous situation where there is a *high* probability of severe injury or death. It should not be considered for property damage unless personal injury risk is present.

**WARNING**

Indicates a hazardous situation which has *some* probability of severe injury. It should not be considered for property damage unless personal injury risk is present.

**CAUTION**

Indicates a hazardous situation which *may result in a minor injury*. Caution should not be used when there is a possibility of serious injury. Caution should not be considered for property damage accidents unless a personal injury risk is present.

**Attention:** A situation where material could be damaged or the function impaired.

**Notice:** Indicates a statement of company policy as the message relates to the personal safety or protection of property. Notice should not be used when there is a hazardous situation or personal risk.

*Note:* Indicates important information that provides further instruction.

## CHAPTER 2: GENERAL SAFETY RECOMMENDATIONS

**WARNING**

Do not install, operate or service this product unless you have read and understand the General Safety Recommendations, Warning Labels, contained in this manual. Failure to do so may result in bodily injury, or property damage.

**WARNING**

Read, study and understand the installation and operating instructions contained in, or referenced in this manual before operating. If you do not understand the instruction, ask a qualified technician. Failure to do so may result in bodily injury, or property damage and will nullify all warranties.

**DANGER**

Disconnect all power to the junction box prior to making any electrical connections. Failure to do so may result in serious personal or fatal injury. When uncertain whether power supply is disconnected, always verify using a voltmeter.

**DANGER**

Do not place finger or uninsulated tools inside the electrical controller. Touching wires or other parts inside the enclosure may cause electrical shock, serious injury or death.

**CAUTION**

The Ground wire from the U30 Microprocessor Control 120 VAC Harness, and the Incoming 120 VAC Ground wire must be connected to the Ground screw located within the Header.

**CAUTION**

If the door appears broken or does not seem to work correctly, it should be immediately removed from service until repairs can be carried out or a qualified service technician is contacted for corrective action.

**Notice:** This manual, the owner's manual and all other associated manuals must be given to and retained by the purchasing facility or end user.

**Notice:** Wiring must meet all local, state, federal or other governing agency codes.

**Notice:** All electrical troubleshooting or service must be performed by qualified electrical technicians and must comply with all applicable governing agency codes.

*Note:* All Adjustments must be made with a small screwdriver. Do Not use a pencil.

*Note:* Do Not take shortcuts.

*Note:* A Resettable Fuse is located in the Power Supply Module. Do not attempt to repair the U30 Microprocessor Control or the Power Supply Module other than resetting the fuse.

## CHAPTER 3: SCOPE

### SECTION 3.1: To the Installer

The purpose of this manual is to familiarize the installer and purchaser with the proper installation and operation of this system. It is essential that this equipment be properly installed and operational before the door is used by the public. In the United States, ANSI Standard 156.10 (Used to cover Full Energy doors) and ANSI Standard 156.38 (Used to cover Low Energy doors) apply. Other local standards or codes may apply. Use them in addition to the ANSI standards.

The owner should determine the door is operating properly and should immediately call for service if there is any malfunction. All installation changes and adjustments must be made by qualified, NABCO trained technicians.

If after troubleshooting a problem, a satisfactory solution cannot be achieved, please call Nabco Entrances at 1-877-622-2694 between 8 am – 4:30 pm Central time for additional assistance. All installation changes and adjustments must be made by qualified, NABCO trained technicians.

## CHAPTER 4: ELECTRICAL SPECIFICATIONS

*Note: NABCO factory utilizes Underwriters Laboratories (UL) recognized component wire, terminals and connector housings to manufacture GT-1175 Slide Door systems.*

**Table 1** Electrical

Electricity	Description
Power Input	120 ( $\pm 10\%$ ) AC 50-60Hz, 5 Amps
Available current for accessories	U Series Control 0.35 Amps 12 Volts DC
Available wire size for incoming power	14 AWG
Power Source	20 VAC ( $\pm 10\%$ ) 50-60Hz, 100 VA (Class 2) (Use genuine Class 2 power supply module ONLY)
Current Consumption	Max. 5A
Power Output (#9DC, 12V and #7)	12 VDC 0.35 amps (350 mA) Class 2 Power Supply
Output Rating (#OUT A, #OUT B, and #OUT C)	Relay Output <ul style="list-style-type: none"> <li>▶ Max. 30V (42.4V peak)</li> <li>▶ Max. 5A (0 to 20V) or 3.2A (20 to 30V)</li> <li>▶ Class 2 Load Only</li> </ul>
Output Rating (# OUT and #7)	Open collector Transistor Output <ul style="list-style-type: none"> <li>▶ Max. 30V (42.4V peak)</li> <li>▶ Max 50mA</li> <li>▶ Class 2 Load Only</li> </ul>

**Table 3** Module Consumption

Module	Function	Power Source	Current Consumption
Optex Beam	Beam & Control	12 to 24 AC or DC	160mA
CP/RX Radio Control Receiver	RF Signal Transmission	12 to 24 AC or DC	50mA

(ea.unit) at 12VDC

**Table 4** Sensor Consumption

Module	Function	Power Source	Current Consumption
Acusensor	Infrared	12 to 24 AC or DC	100mA
BEA IXIO	Infrared + Microwave	12 to 24 VAC	100mA
		12 to 35 VDC $\pm 10\%$	
Optex i-one	Infrared	12 to 24 VAC or 12 to 30 VDC	130mA
Acuzone T	Infrared + Microwave	12 to 24VAC $\pm 10\%$ (50 / 60 Hz)	6mA
		12 to 30VDC $\pm 10\%$	

(ea.unit) at 30VDC

**SECTION 4.1: Output Power Guideline**

**CAUTION**

**The U30 Microprocessor Control and/or the NABCO Power Supply Module Must Not be used to output power to Magnetic Locks or Electric Strikes.**

TOTAL current draw from the U30 Microprocessor Control must not exceed 350 mA (0.35 amps) when outputting power to:

- ▶ Sensors    ▶ Accessories
- ▶ Modules   ▶ Auxiliary Equipment

If TOTAL current draw exceeds 350mA (0.35 amps) the installer must utilize an auxiliary power supply such as a 24 VAC Transformer.

**CAUTION**

**The U30 Microprocessor Control and/or the NABCO Power Supply Module Must Not be used to output power to Magnetic Locks or Electric Strikes.**

To determine if an auxiliary power supply must be used, add together each current draw for each device. Please refer to the formula shown below:

Example: A GT-1175 Slide Door is to be fitted with the following devices:

2 x Optex i-one Sensors @ 130 mA = 260 mA

1 x Optex Beam Module @ 160 mA = 160 mA

Total = 420 mA

420mA exceeds 350mA. An Auxiliary Power Supply must be used to supply power to the Optex Beam Module.

**CHAPTER 5: 120 VAC GENERAL WIRING**

**WARNING**

**Shut the installation site, branch Circuit Breaker OFF. Failure to do so may result in serious personal or fatal injury. When uncertain whether power supply is disconnected, always verify using a voltmeter.**

**WARNING**

**All high voltage electrical connections must be made by licensed electricians according to National and Local electrical codes/regulations.**

**CAUTION**

**Permanent wiring shall be employed as required by local codes.**

**CAUTION**

**Keep all Incoming 120 VAC wiring separate from low voltage wiring within Header. 120 VAC Power wires must be routed (separate from other wiring) located near the top of inside Header.**

**CAUTION**

**Ensure that the Grounding of the Electric Power Supply is installed/connected in a proper way (especially the PE Cable from the Building Side).**

**Attention:** Insert all Incoming 120 VAC Power wires into the pre drilled Electric Service Access Hole located at the left or right side of Header End Cap.

**Attention:** Electrical circuit to Nabco operator must not be not shared with other equipment such as lighting, cash registers, or any device that might cause electrical interference on the circuit.

**Attention:** Any non-factory low voltage wiring added inside the Header must be Type CL2 wire or the equivalent in accordance with Article 725 of the NEC.

*Note: It is recommended for the Installer to house all Incoming 120 VAC wires within an Electrical Conduit.*

1. Ensure Rocker Switch options are set as follows: ON and OFF only.

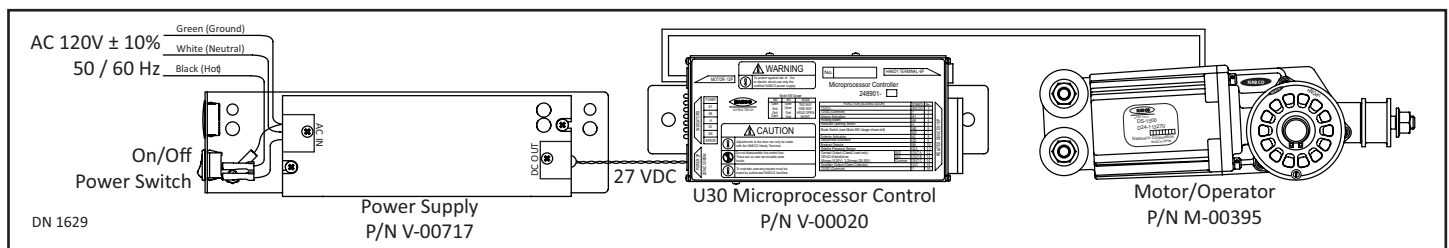

# CHAPTER 6: GENERAL WIRING

## SECTION 6.1: (2) Acusensor M and (1) Holding Beam (With Monitoring)

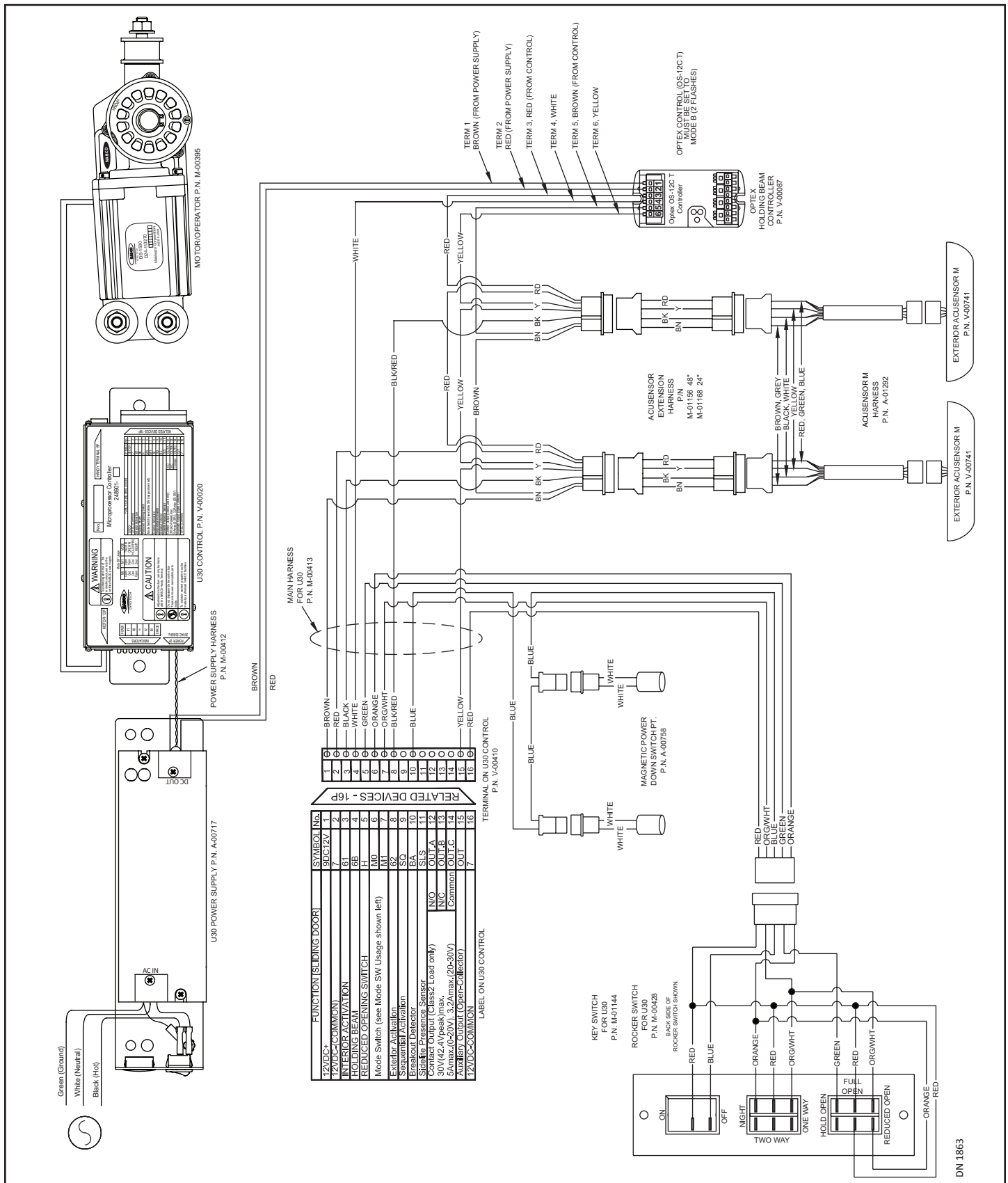

**SECTION 6.2: (2) Sensors and (1) Holding Beam (With Monitoring)**

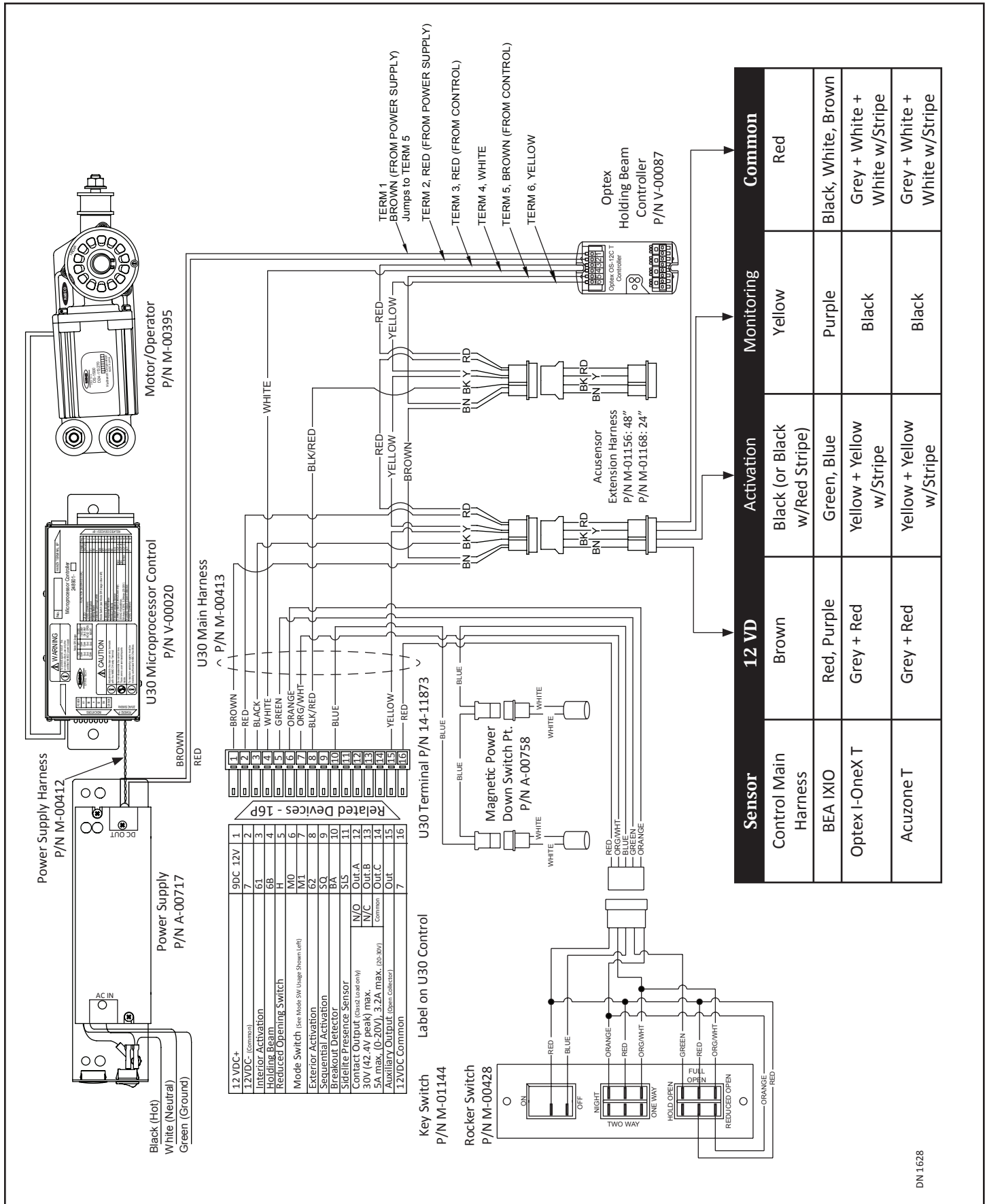

DN1628

**SECTION 6.3: (2) Acusensor M for Sidelite Safety (Field Retrofit)**

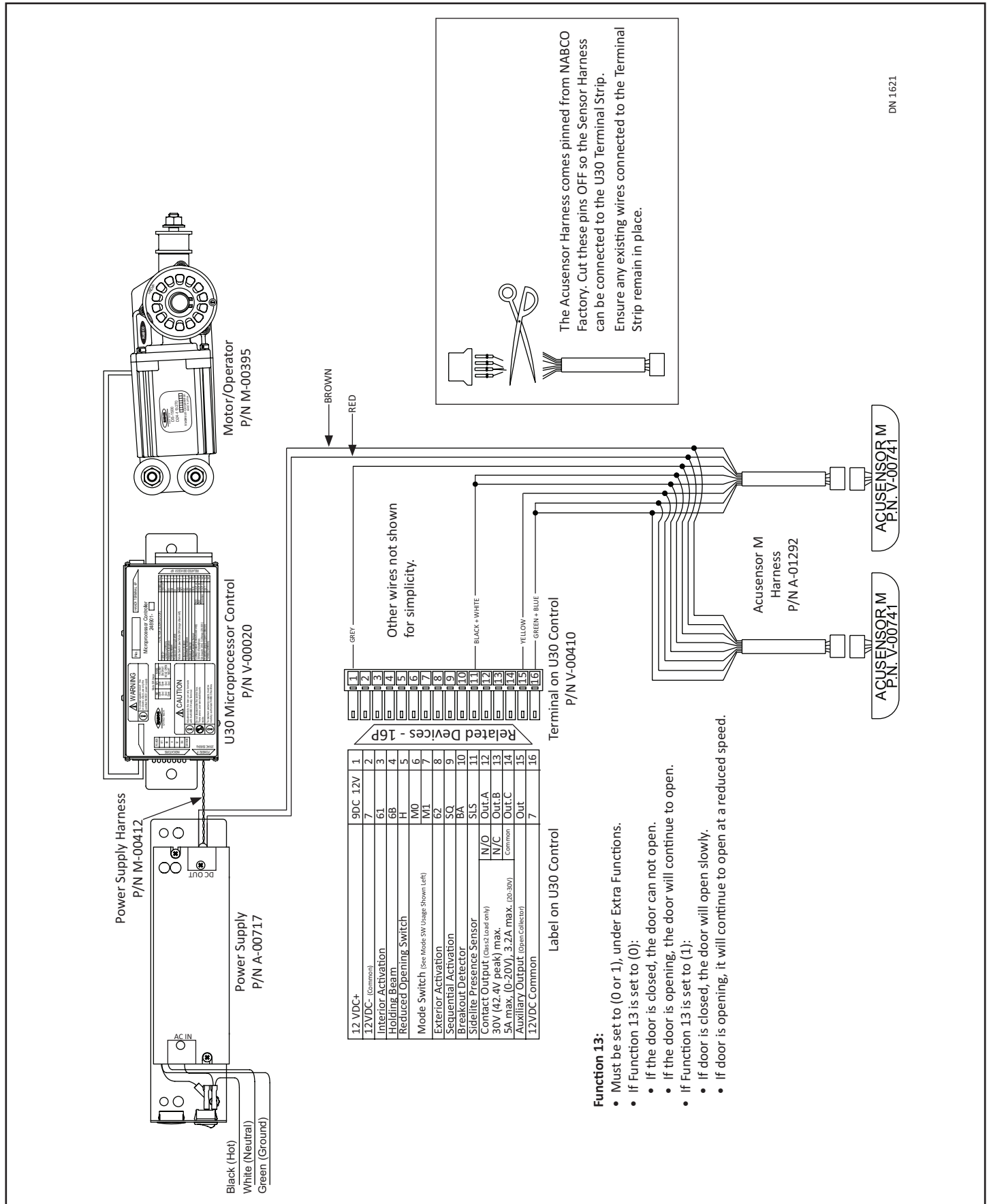



# CHAPTER 7: CUSTOM WIRING

## SECTION 7.1: U30 Configured for Remote Control - Switching from Two Way to One Way Mode

**NOTES:**

1. The Blue Wire must be connected to the Red Wire for door to operate.
2. Remote switch must be dry contacts (no voltage).
3. To make modifications easier (or reversal of modifications easier) it is recommended to use the Rocker Switch Extension Harness, P/N A-00967.
4. Other wires not shown for simplicity.
5. Cap off all unused wires.

Mode	M0 to Common (Orange to Red)	M1 to Common (Orange/White to Red)
Two way (Auto)	Open	Open
One Way Mode (Exit Only)	Closed	Open
Night Mode	Open	Closed
Hold Open	Closed	Closed

FUNCTION (SLIDING DOOR)	7SYMBOL	NO.
12 VDC+	9DC 12V	1
12VDC (COMMON)	7	2
INTERIOR ACTIVATION	61	3
HOLDING BEAM	6B	4
REDUCED OPENING SWITCH	H	5
Mode Switch (see Mode SW Usage shown left)	M0	6
	M1	7
Exterior Activation	62	8
Sequential Activation	SQ	9
Breakout Detector	BA	10
Sidelite Presence Sensor	SLS	11
Contact Output (Class 2, load only)	N/O	12
30V (42-4V peak) max.	N/C	13
5A max (0-20V), 3.2A max. (20-30V)	Common	14
Auxiliary Output (Open-Collector)	OUT	15
12 DC - Common	7	16

Label on U30 Control

NO.	SYMBOL
1	RED
2	ORG/WHT
3	BLUE
4	GREEN
5	ORANGE
6	ORG/WHT
7	RED
8	BLUE
9	ORG/WHT
10	BLUE
11	BLUE
12	BLUE
13	BLUE
14	BLUE
15	BLUE
16	BLUE

Terminal on U30 Control  
P/N V-00410

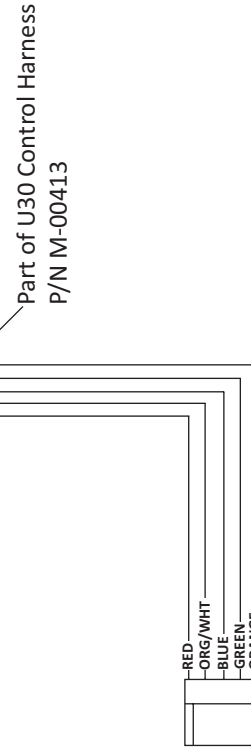

At Rocker Switch, Splice as Shown

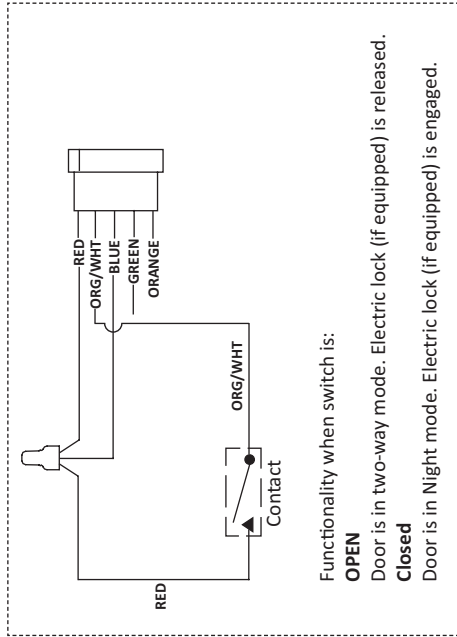

DN 2090  
From DN 0291

**SECTION 7.2: U30 Configured for Remote Control - Switching from Two Way to Night Mode**

**NOTES:**

1. The Blue Wire must be connected to the Red Wire for door to operate.
2. Remote switch must be dry contacts (no voltage).
3. To make modifications easier (or reversal of modifications easier) it is recommended to use the Rocker Switch Extension Harness, P/N A-00967.
4. Other wires not shown for simplicity.
5. Cap off all unused wires.

Mode	M0 to Common (Change to Red)	M1 to Common (Change/White to Red)
Two way (Auto)	Open	Open
One Way Mode (Exit Only)	Open	Closed
Night Mode	Closed	Open
Hold Open	Closed	Closed

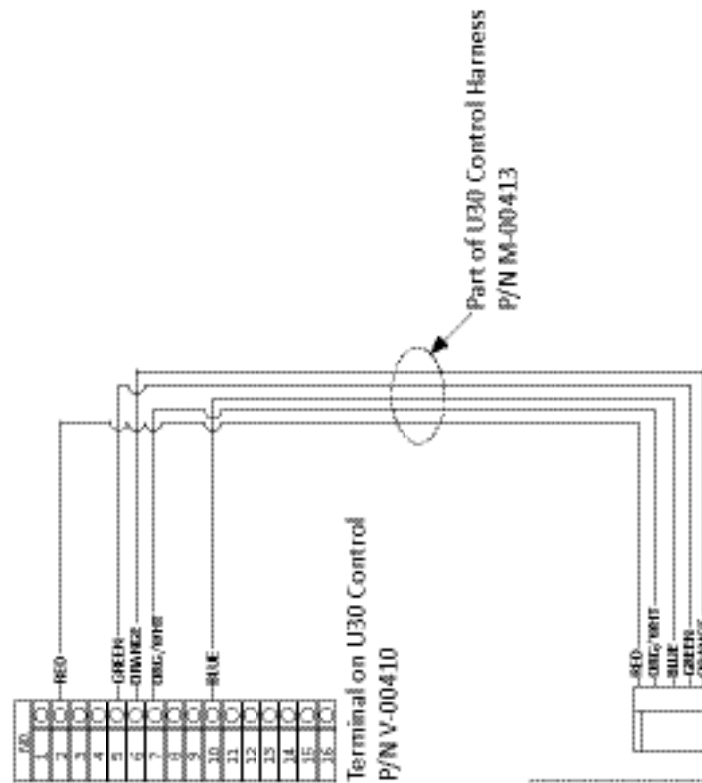

FUNCTION	TERMINAL NO.
POWER	1
POWER	2
POWER	3
POWER	4
POWER	5
POWER	6
POWER	7
POWER	8
POWER	9
POWER	10
POWER	11
POWER	12
POWER	13
POWER	14
POWER	15
POWER	16

Label on U30 Control

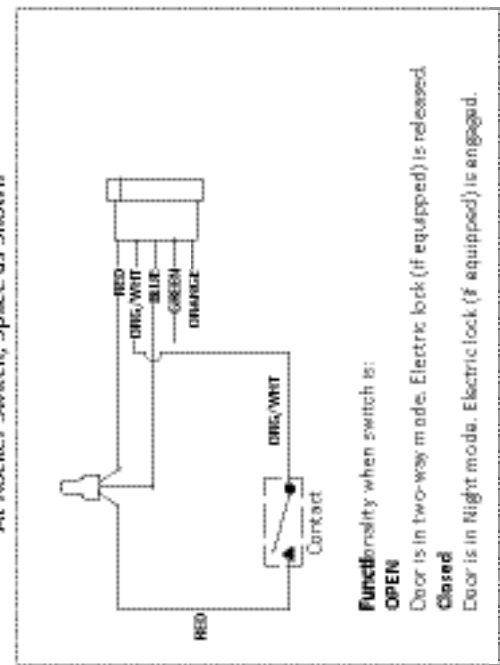

**SECTION 7.3: U30 using Card Reader or other Secure Activation Devices**

FUNCTION (SLIDING DOOR)	7SYMBOL	NO.
12 VDC+	9DC 12V	1
12VDC-(COMMON)	7	2
INTERIOR ACTIVATION	61	3
HOLDING BEAM	6B	4
REDUCED OPENING SWITCH	H	5
Mode Switch (see Mode SW Usage shown left)	M0	6
	M1	7
Exterior Activation	62	8
Sequential Activation	SQ	9
Breakout Detector	BA	10
Sidelite Presence Sensor	SLS	11
Contact Output (Class 2 load only)	N/O	OUT A 12
30V (42.4V peak)max.	N/C	OUT B 13
5A max (0-20V), 3.2A max. (20-30V)	Common	OUT C 14
Auxiliary Output (Open-Collector)	OUT	15
12 DC - Common	7	16

Label on U30 Control

RELATED DEVICES - 16P

NO.	
1	○
2	○
3	○
4	○
5	○
6	○
7	○
8	○
9	○
10	○
11	○
12	○
13	○
14	○
15	○
16	○

Terminal on U30 Control  
P/N V-00410

Key Pad or Card Reader on  
secure side of Door  
N.O. - Dry Contacts

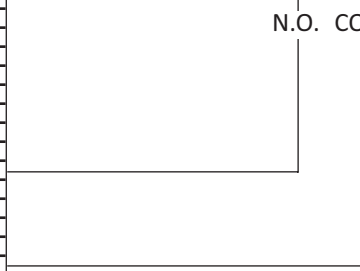
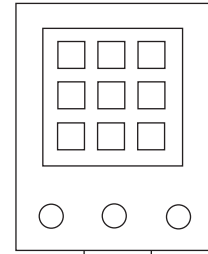

1. Connect the Key Pad, Card Reader or Key Switches to Terminals 11 and 16 as shown.
2. Using the Handy Terminal, program the U30 Control as follows:
  1. Go to Extra Function Adjustments.
  2. Select Function (13).
  3. Select Settings 3.
    - a. The Device is enabled to activate the door regardless of which Rocker Switch Mode is selected (Auto, One Way, or Night).
    - b. Device must provide Normally Open, Dry Contacts (No Voltage)

DN 1622  
From DN 0291

## CHAPTER 8: WIRING FOR LOCKS

### SECTION 8.1: Electric Lock Wiring

*Note: Electric Locks can not prevent Breakout. If preventing Breakout is deemed necessary, panic hardware must be fitted to the Door Panels.*

The Electric Lock is optional and can come in (1 of 2) configurations:

- ▶ Fail Safe
  - Allows the Door Panel to be manually opened if power is turned Off.
- ▶ Fail Secure
  - Will not allow the Door Panel to be manually opened if power is turned Off.

Electric Locks are used to prevent Door Panels from opening until they are activated by the U30 Microprocessor Control when it receives a signal from a:

- ▶ Remote Switch
- ▶ Transmitter
- ▶ Activation Device on the face of the Door

Electric Locks are pre-installed at the NABCO Factory. Only the Strike mounted on the Header may need to be adjusted.

### SECTION 8.2: Adjust the Strike

1. Close Door Panel(s).
2. Go inside the Header. Loosen the Strike Mounting Bolts that is holding the Strike Bracket secure to the Header.
3. Slide the Strike to align with the Latch Bolt in the fully closed position.
4. Tighten the Strike Mounting Bolts.
  - a. Do not overtighten.

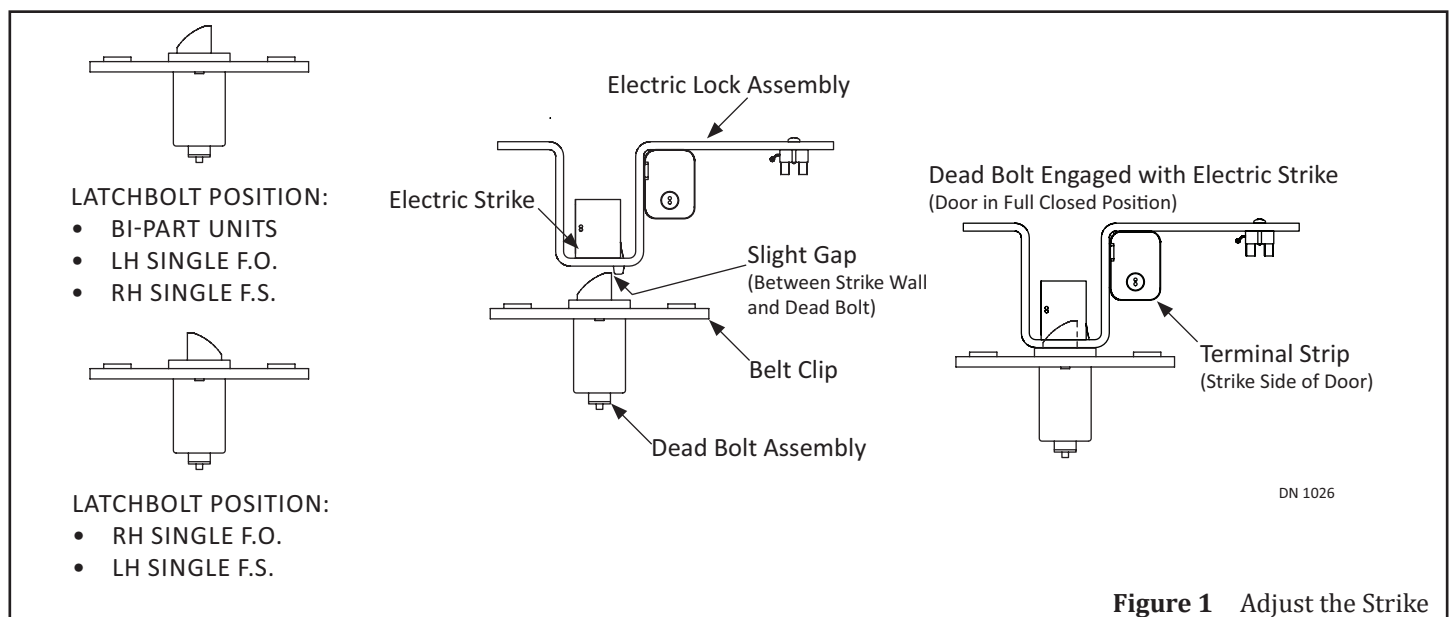

**SECTION 8.3: U30 with Fail Safe Electric Lock**

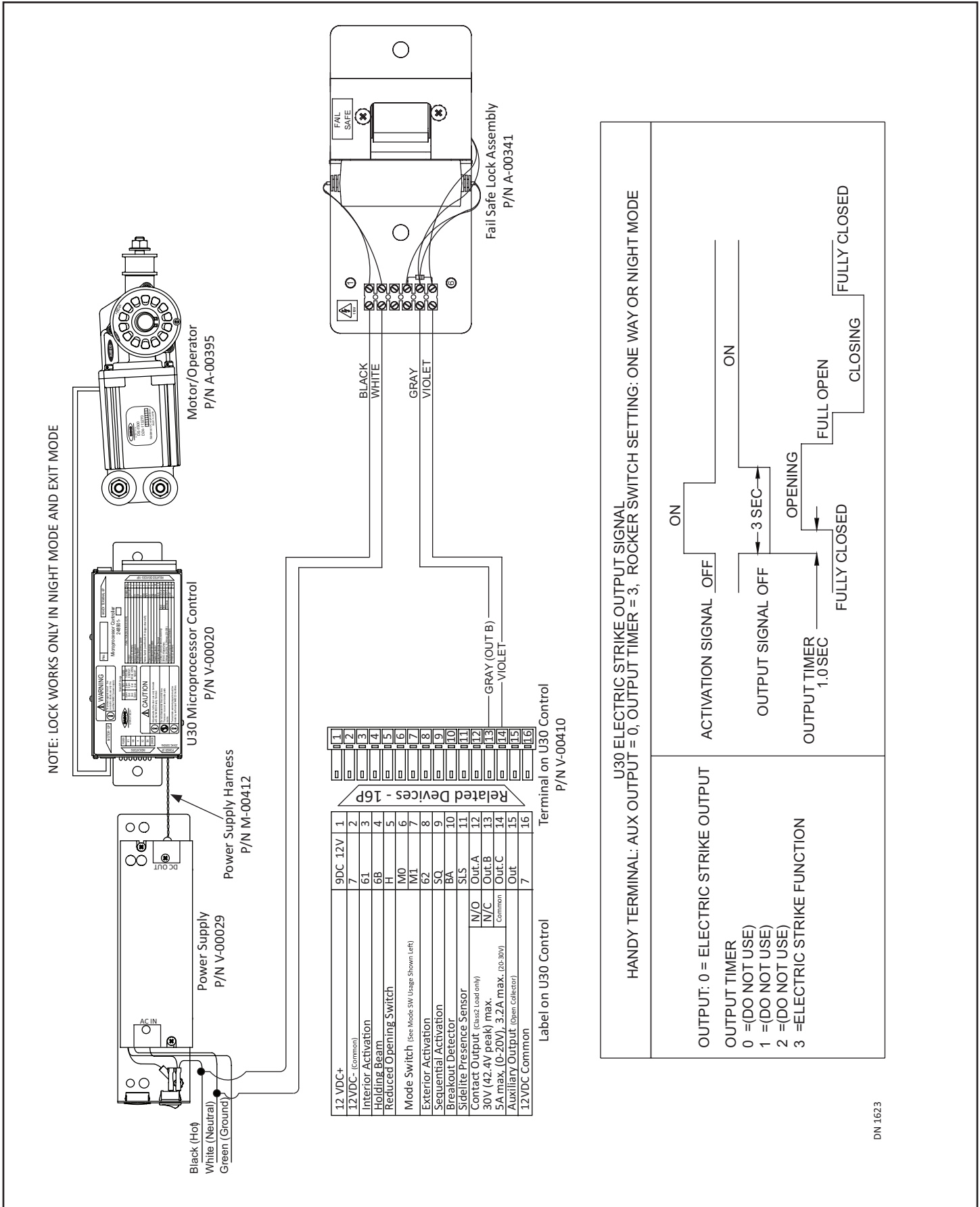

DN 1623

**SECTION 8.4: U30 with Fail Secure Electric Lock**

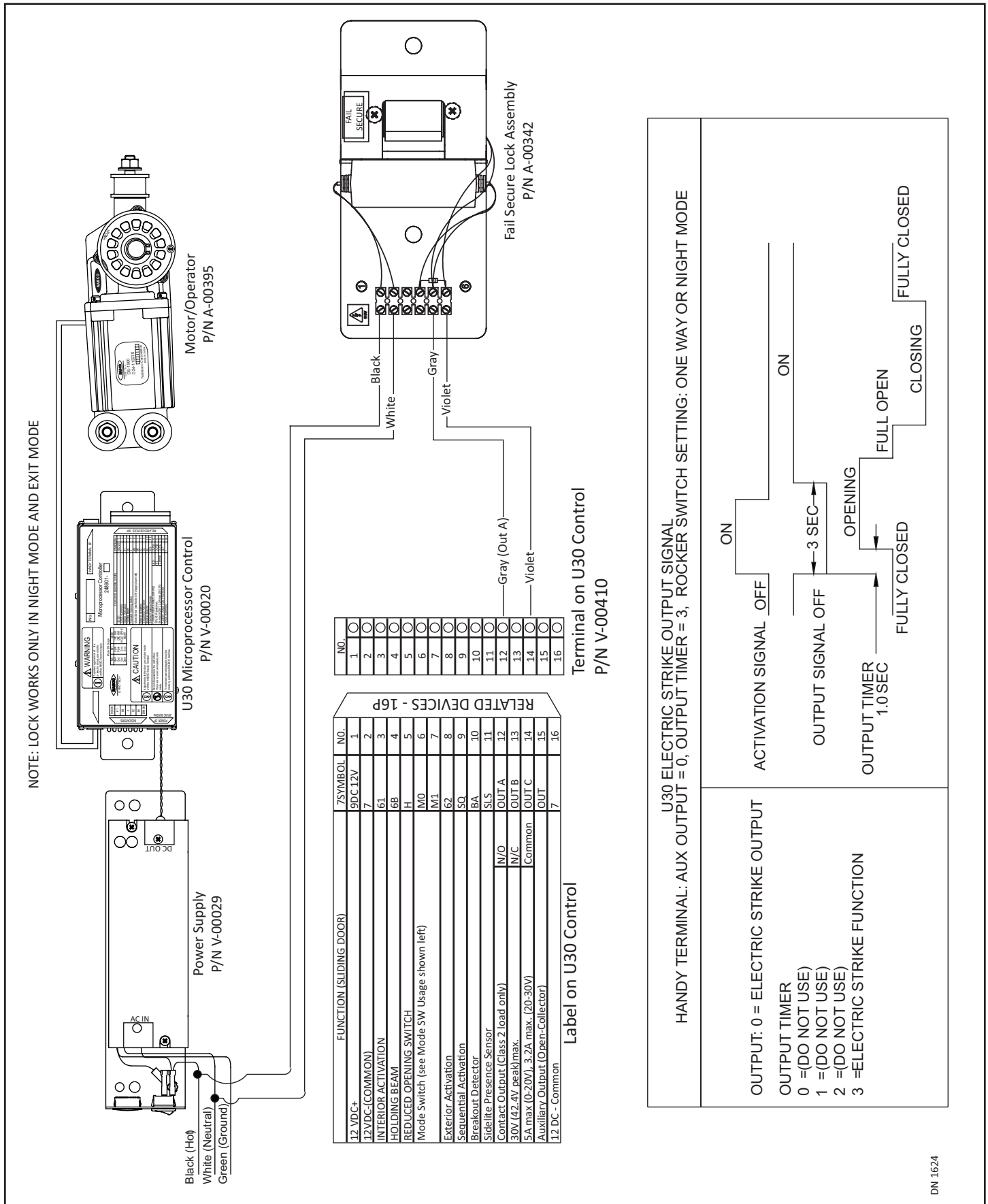

**SECTION 8.5: Magnetic Lock Wiring**

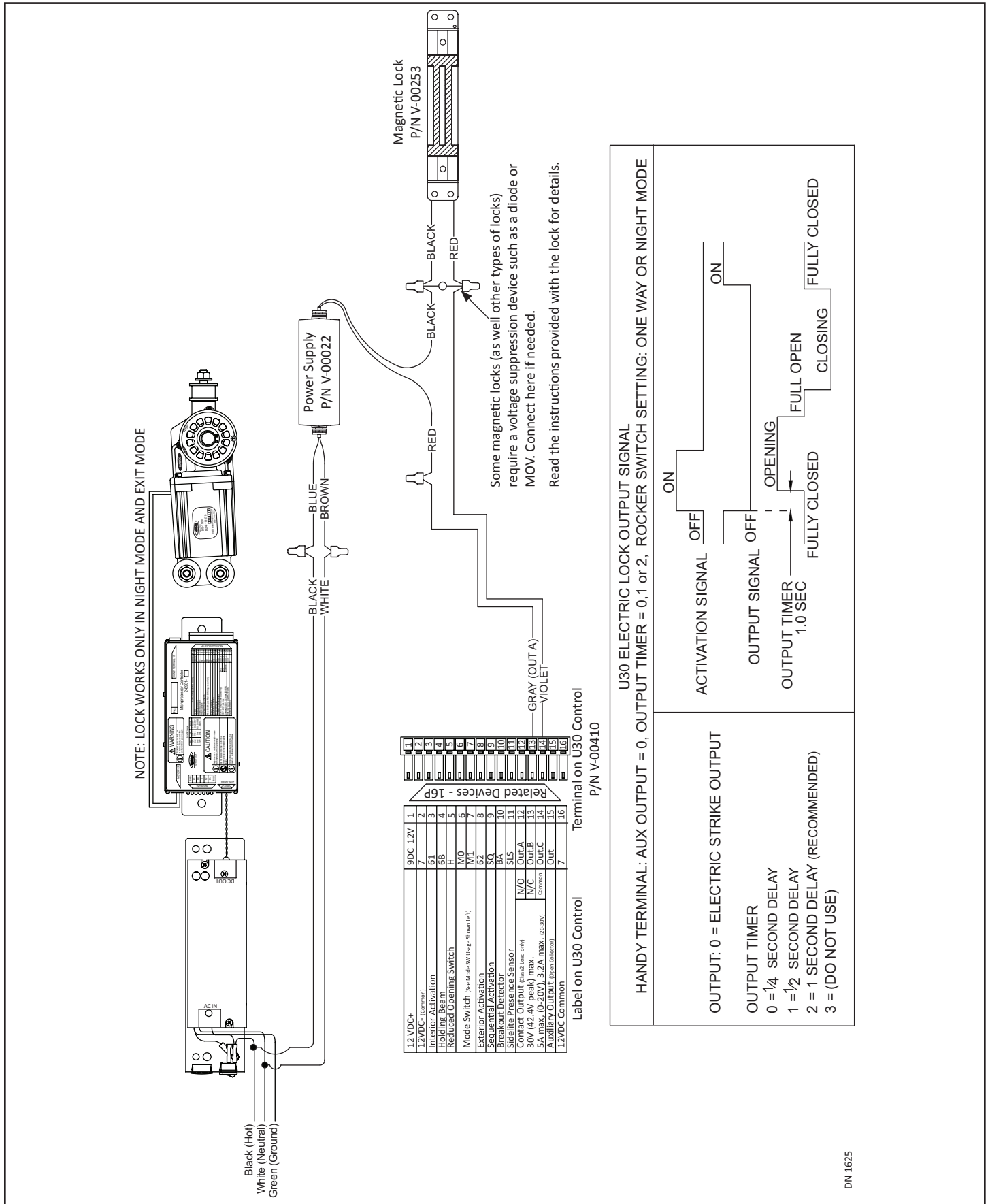

## CHAPTER 9: INFRARED HOLDING BEAMS

### SECTION 9.1: Holding Beam for Slide Door

On GT-1175 Slide doors, the Optex OS-12C Module Infrared Beam is installed and wired at the NABCO factory. This unit is shipped complete with Emitter(s), Receiver(s) and a Control Box. Both the Emitter and Receiver are flush mounted on the inside, Slide door Jamb Tube and Sidelite Strike Stile, or both Strike Stiles, directly across from each other. The Rcvr/Emit are installed 21 inches from the floor. If deemed necessary, a second Rcvr/Emit may be installed 54 inches from the floor.

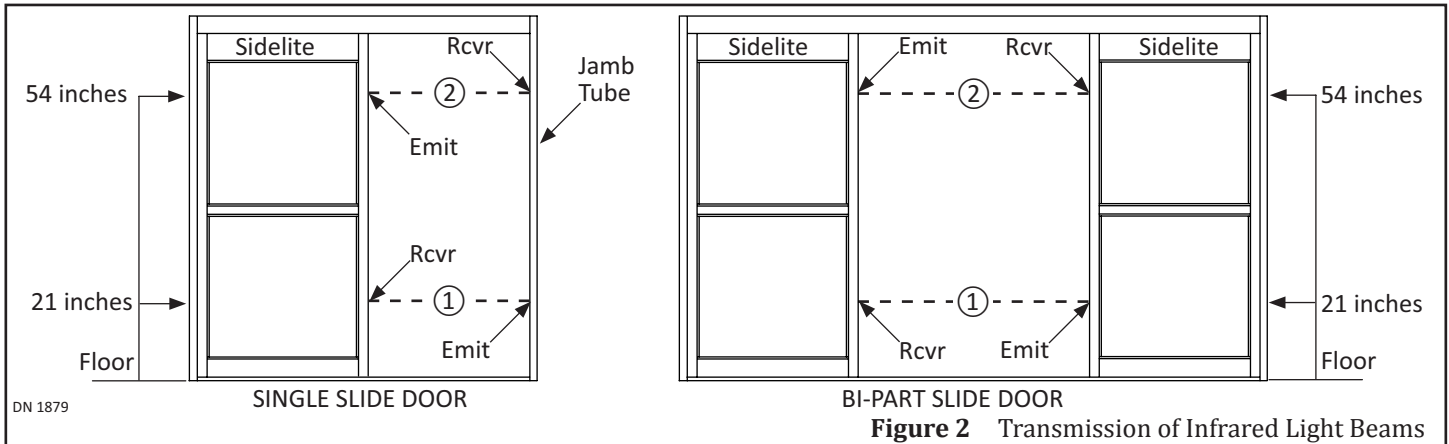

**Figure 2** Transmission of Infrared Light Beams

In the event a pedestrian or object crosses the threshold, breaking a beam, the beam controller will send a signal to the door control to hold the door open until the threshold is clear and the beam is restored.

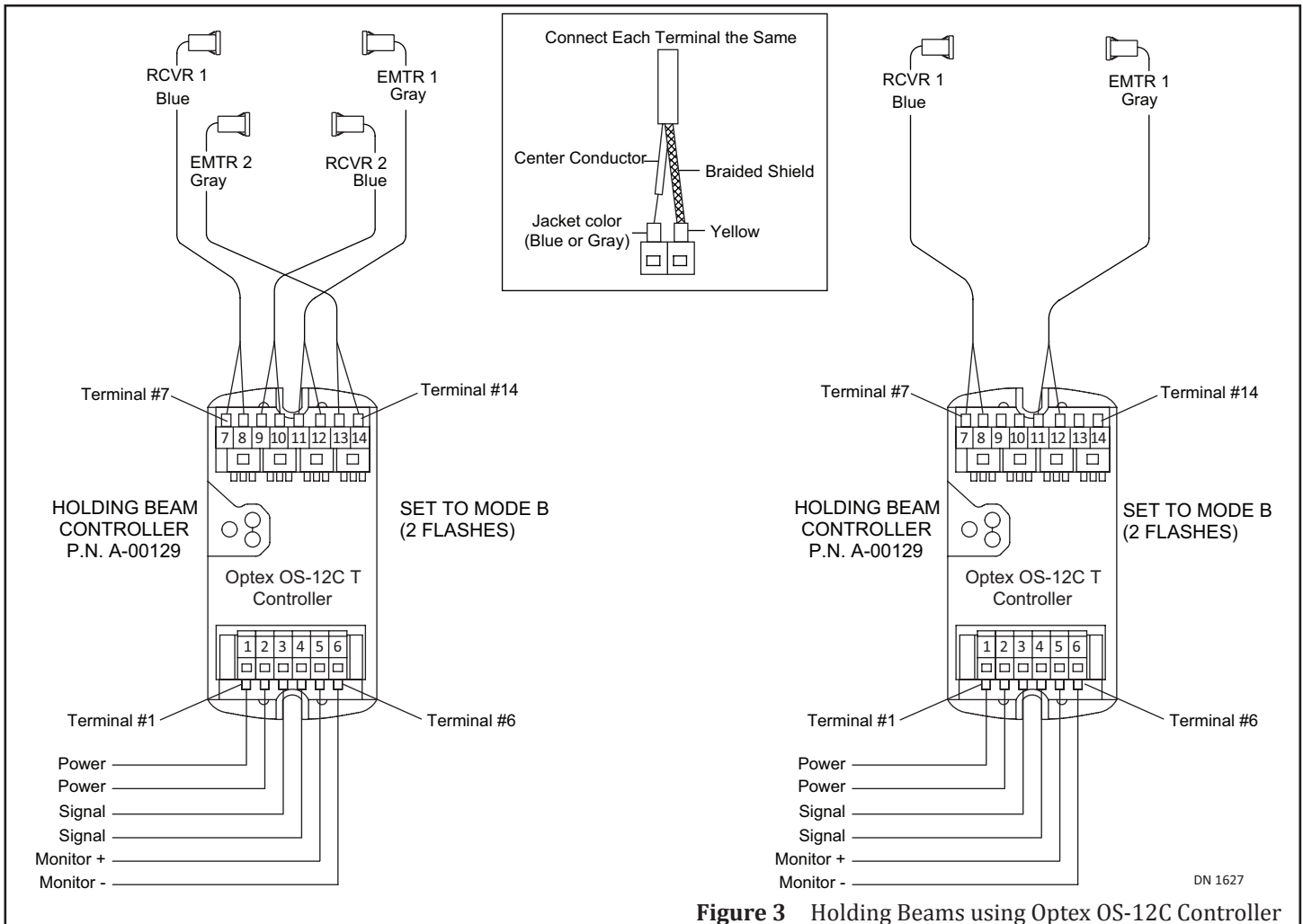

**Figure 3** Holding Beams using Optex OS-12C Controller



### SECTION 9.2: Holding Beam for Breakout

In the event that a panel is broken out (emergency egress), the panel will break the beam. The beam controller signals the door control to stop. The door will not run again until all panels are returned to their proper location and the beam is restored.

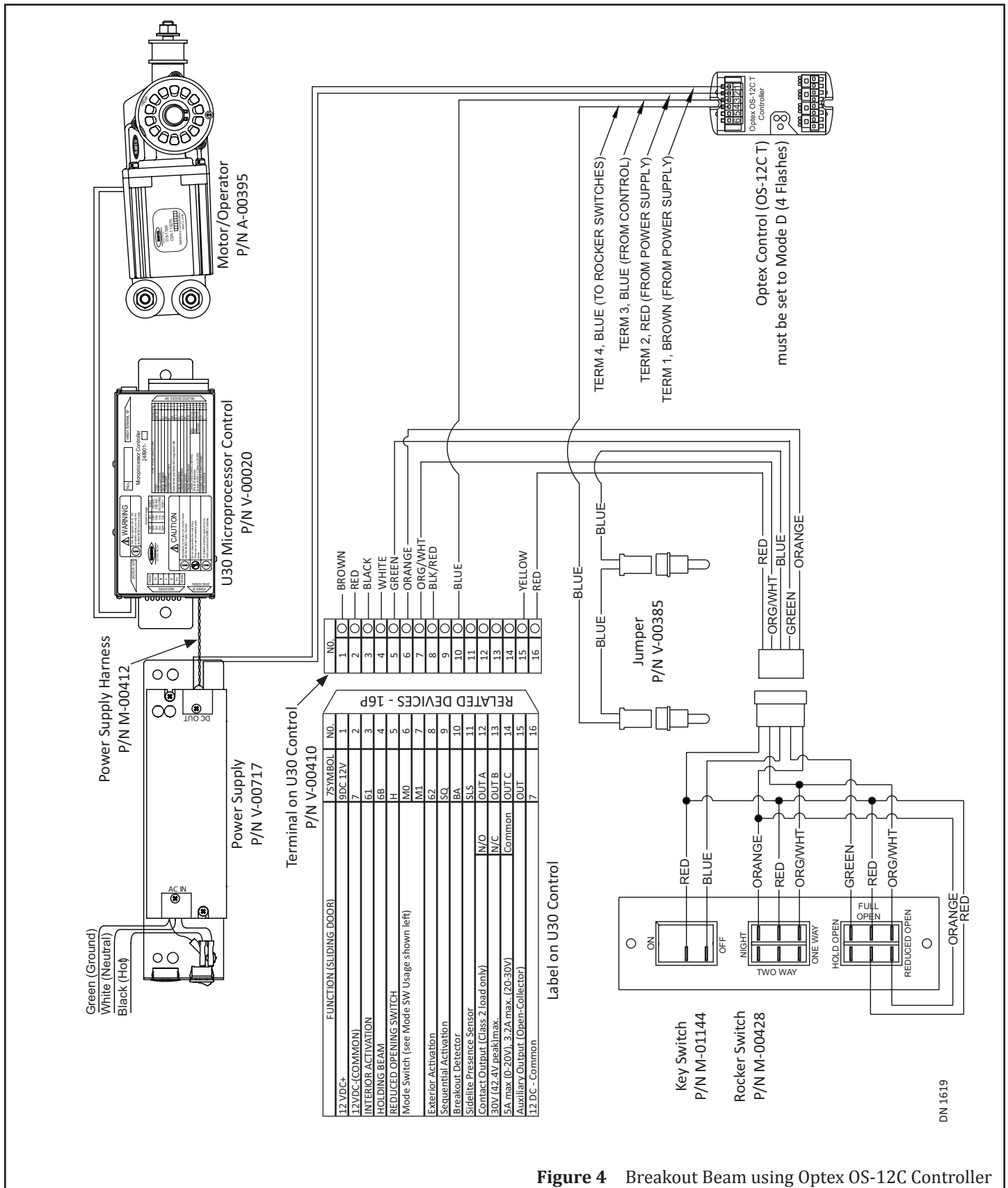

Figure 4 Breakout Beam using Optex OS-12C Controller

## CHAPTER 10: TROUBLESHOOTING

Trouble	Action
Slide door panicked open. System fails to shut down.	Check wiring on the magnetic power down switches. Blue (BA) circuit must open for system to shut down.
Slide door does not open when power is applied.  Do Not manually shut door.	<ul style="list-style-type: none"> <li>▶ Confirm the Breakout Panel(s) is closed completely.</li> <li>▶ Confirm Blue (BA) circuit is not open. <ul style="list-style-type: none"> <li>• Verification can be done by observing Green (BA) status LED on U30 Controller. If LED in ON, the circuit is Open, and the unit will not operate.</li> </ul> </li> <li>▶ Check that the power down magnet in the top rail of the Breakout panel is installed and aligned with the magnetic power down switch in the bottom of the Header.</li> <li>▶ Confirm Rocker Switch is set to ON not OFF.</li> </ul>
Handy Terminal screen does not change.	<ul style="list-style-type: none"> <li>▶ Confirm the Breakout Panel(s) is closed completely.</li> <li>▶ Confirm Blue (BA) circuit is not open. <ul style="list-style-type: none"> <li>• Verification can be done by observing Green (BA) status LED on U30 Controller. If LED in ON, the circuit is Open, and the unit will not operate.</li> </ul> </li> <li>▶ Check that the power down magnet in the top rail of the Breakout panel is installed and aligned with the magnetic power down switch in the bottom of the Header.</li> <li>▶ Confirm Rocker Switch is set to ON not OFF.</li> </ul>
Door opens and closes very slowly.	<ul style="list-style-type: none"> <li>▶ Check and clear error codes with Handy Terminal.</li> <li>▶ If Handy Terminal is not available, cycling the power will make the control resume normal operation.</li> </ul>
Slide doors do not Open completely.	<ul style="list-style-type: none"> <li>▶ Look for obstructions in the track as well as inside the Header. <ul style="list-style-type: none"> <li>• Check to ensure that Belt Clips are not hitting something.</li> </ul> </li> <li>▶ Check that the Mode Switch on the panel is not in "Reduced Opening" mode. Also verify that the Green (H) status LED on the U30 Controller is not lit. If this LED is ON, it indicates that there is a signal on the "Reduced Opening" circuit (Green "H" is being shorted to Red 7)</li> <li>▶ Use the Handy Terminal and reinitialize the system.</li> </ul>
Reset the system back to NABCO Factory settings	<ul style="list-style-type: none"> <li>▶ Plug in Handy Terminal and wait for the Slide door to Close. <ol style="list-style-type: none"> <li>1. At "Swing/Slide Stroke?" enter YES.</li> <li>2. At "Swing Door Y or N?" enter YES (even though you have a slide door). <ol style="list-style-type: none"> <li>b. "Swing Door Y or N?" enter NO.</li> </ol> </li> <li>c. System will now initialize as a Slide door to NABCO Factory settings.</li> </ol> </li> <li>3. Set Slide door Stroke according to prompts the Handy Terminal displays.</li> </ul>

**Notice:** If after troubleshooting a problem, and a satisfactory solution cannot be achieved, please call Nabco Entrances at 1-877-622-2694 between 8 am – 4:30pm Central time for additional assistance.

**DO NOT** leave any problem unresolved. If the door cannot be repaired immediately, turn off the door and leave it inoperable until repairs can be made. Advise the owner **NOT** to operate the door in the automatic mode until repairs are effected. **NEVER** leave a door operating without all safety detection systems operational.