

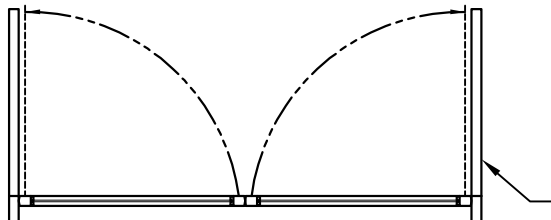

NABCO Entrances Inc.  
 S82 W18717 Gemini Drive Muskego, WI 53150  
 www.nabcoentrances.com 1-877-622-2694

JOB NAME: \_\_\_\_\_  
 LOCATION: \_\_\_\_\_  
 DISTRIBUTOR: \_\_\_\_\_  
 DOOR #: \_\_\_\_\_ DATE: \_\_\_\_\_  
 SHEET \_\_\_\_\_ OF \_\_\_\_\_

**GT20-04 OHC**  
 SIDELOAD HEADER  
 CENTER PIVOT  
 SIMULTANEOUS  
 PAIR OUTSWING

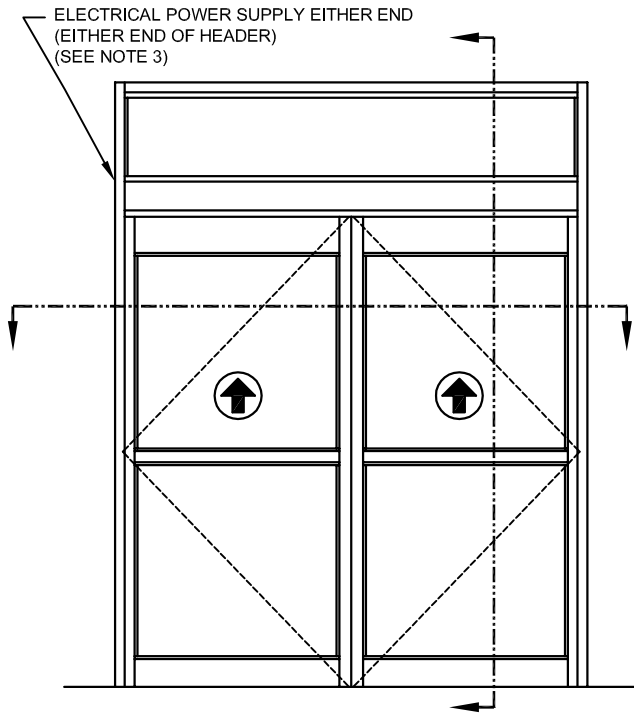

INTERIOR ELEVATION/PLAN

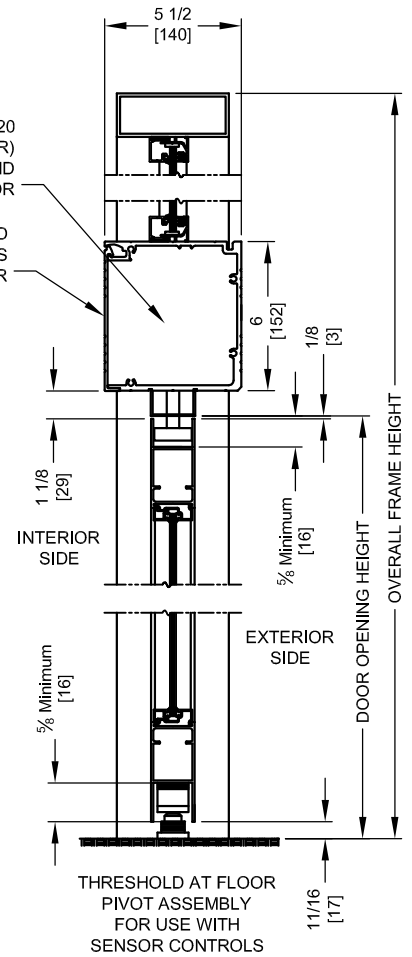
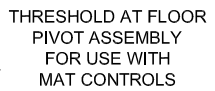
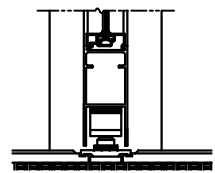
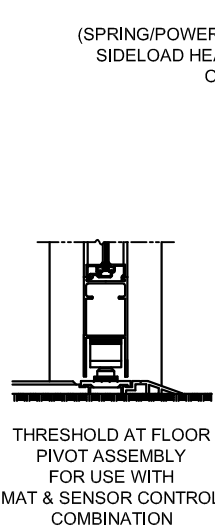

VERTICAL SECTION

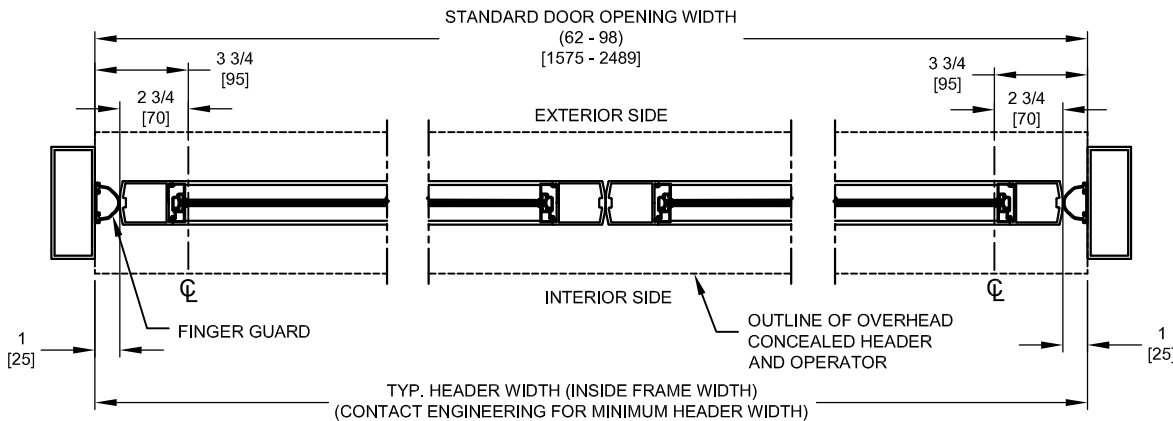

HORIZONTAL SECTION

NOTES:

1. GUIDE RAILS, MATS, PUSH PLATES AND VARIOUS ELECTRONIC DEVICES FOR THE DOOR ACTIVATION AND CONTROL ARE OPTIONAL. CONSULT WITH YOUR NABCO/GYRO TECH DISTRIBUTOR.
2. DOORS AND FRAMES ARE NOT INCLUDED UNLESS NOTED.
3. POWER TO HEADER WILL BE 115VAC, 5 AMP PER OPERATOR PROVIDED BY ELECTRICAL CONTRACTOR.
4. STANDARD HARDWARE SUPPLIED WILL ACCOMMODATE DOOR THICKNESS OF 1 3/4" TO 2 1/4".